

16

467

467

mistral
16



Les numéros des illustrations ainsi que ceux du dessin ci-dessous et des cordages qui accompagnent le bateau, sont les mêmes dans les trois cas.

• The numbers of the illustrations, the drawing below, and the rigging coming with the boat, are the same in all three cases.

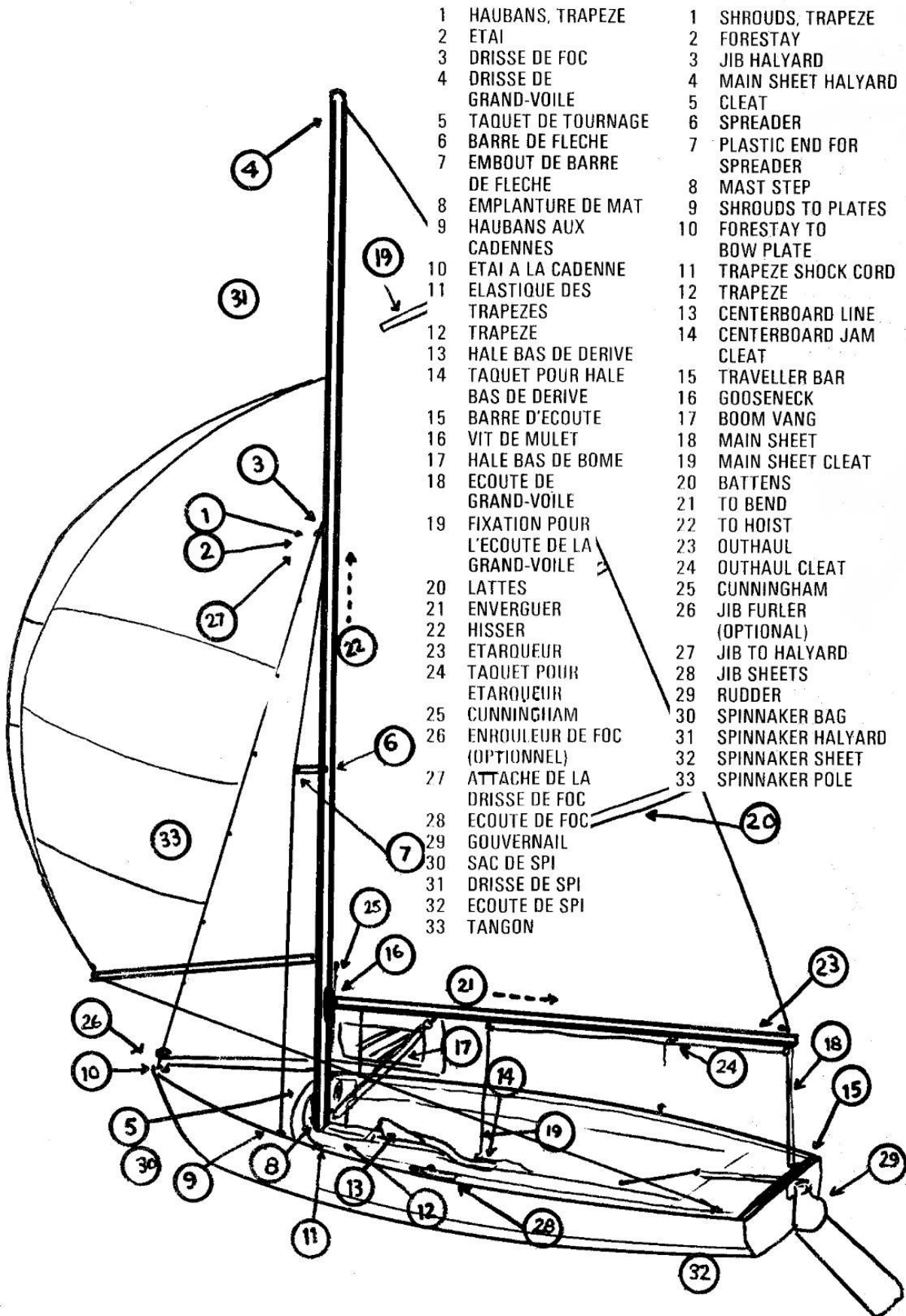

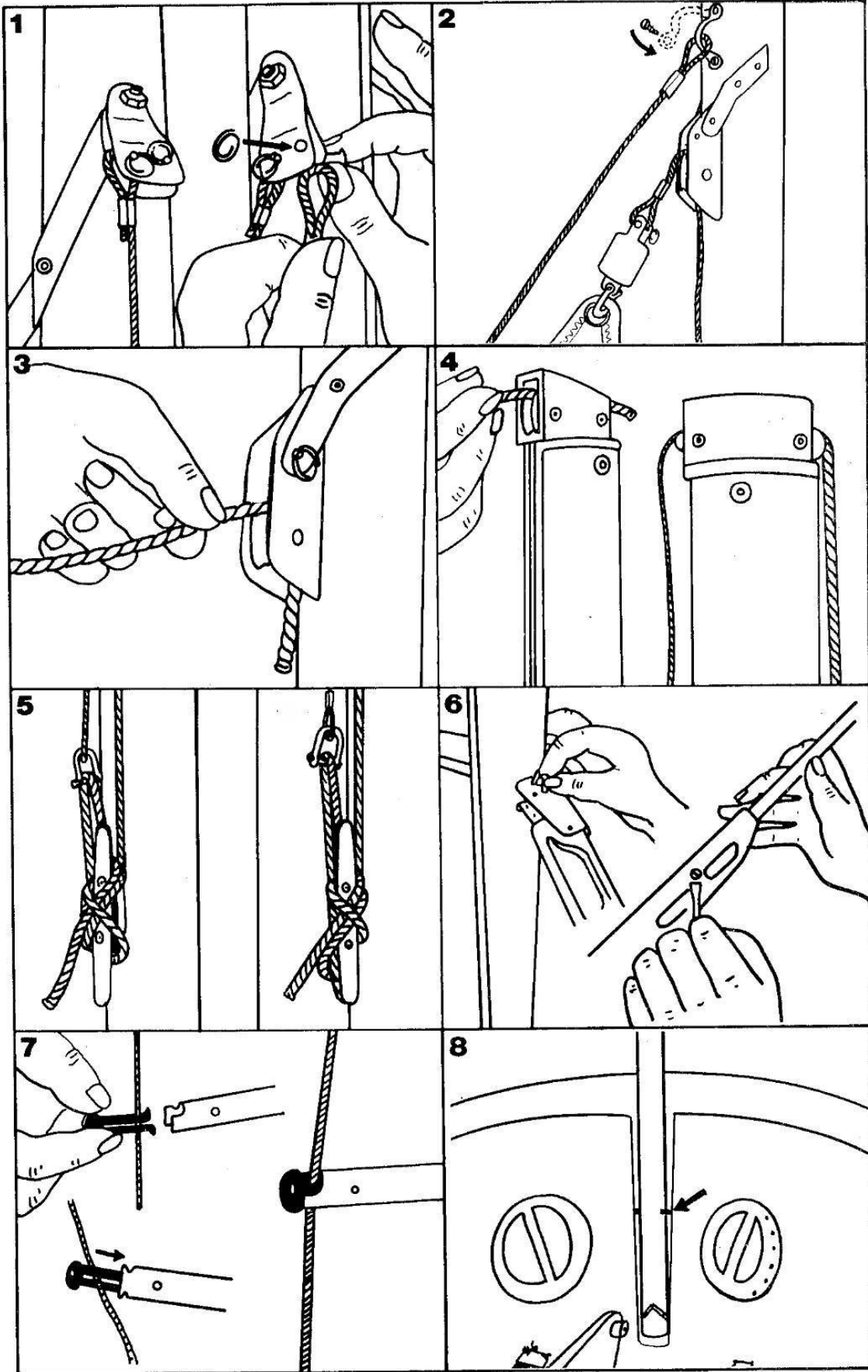

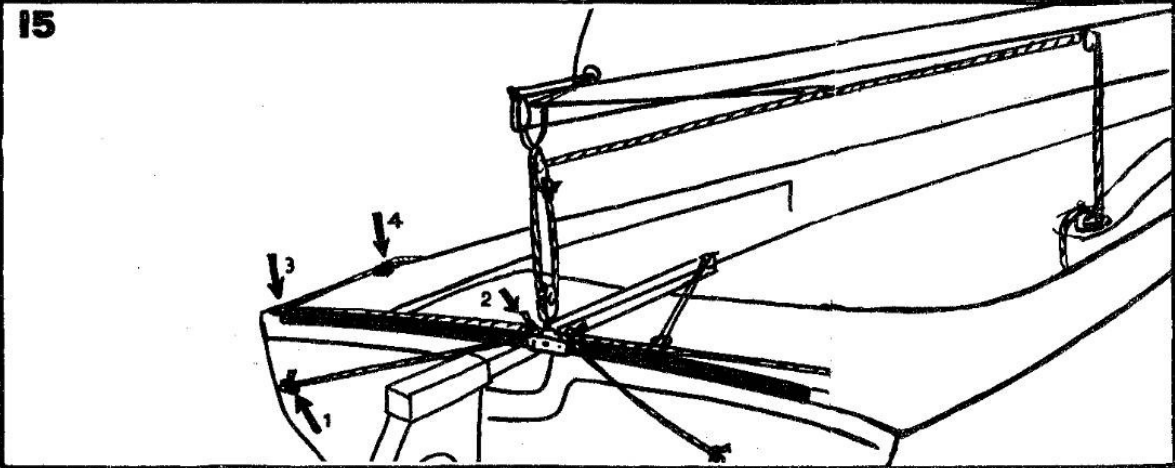
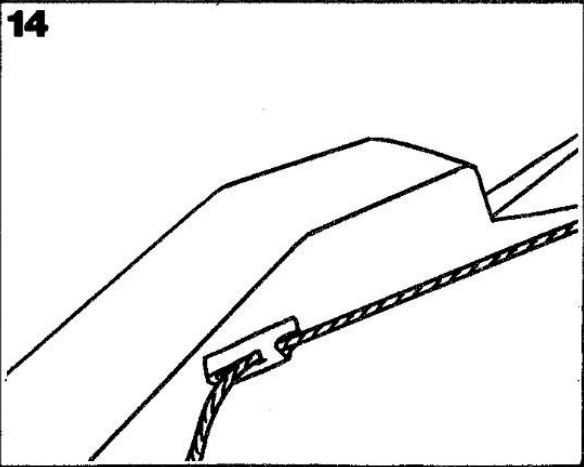
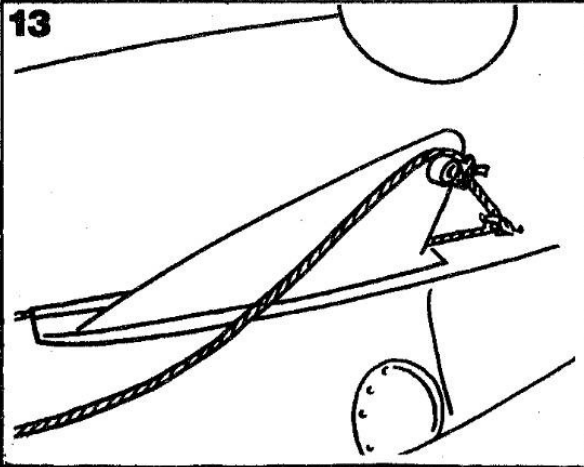
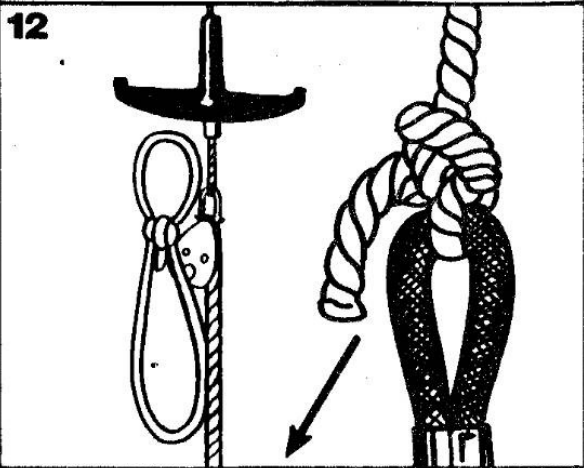
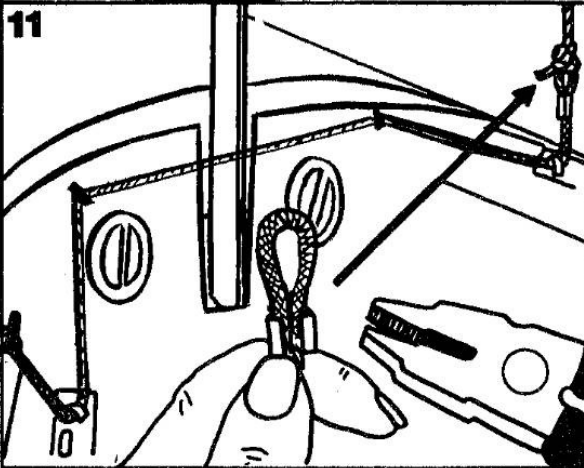
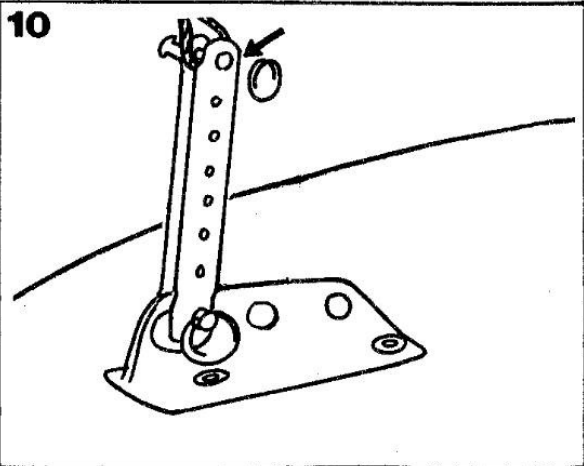
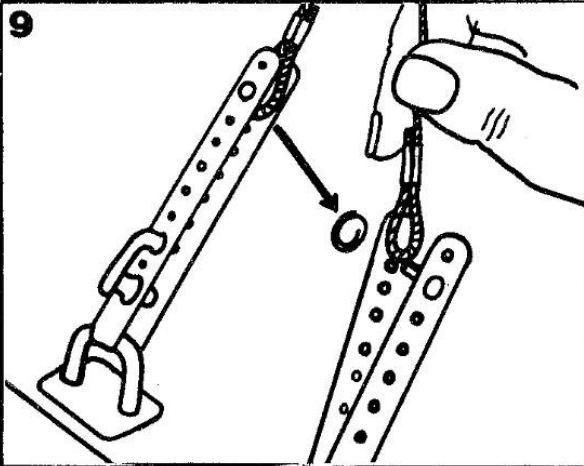

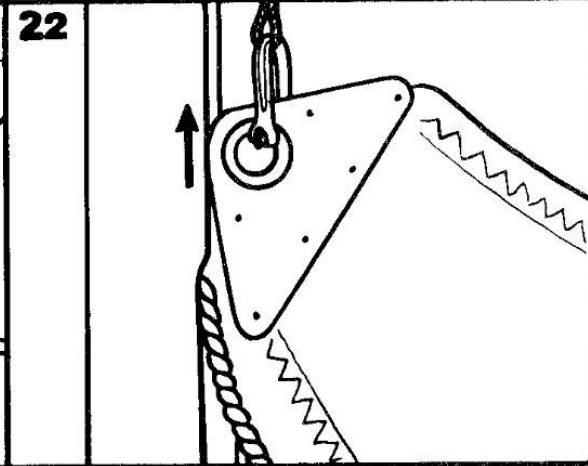
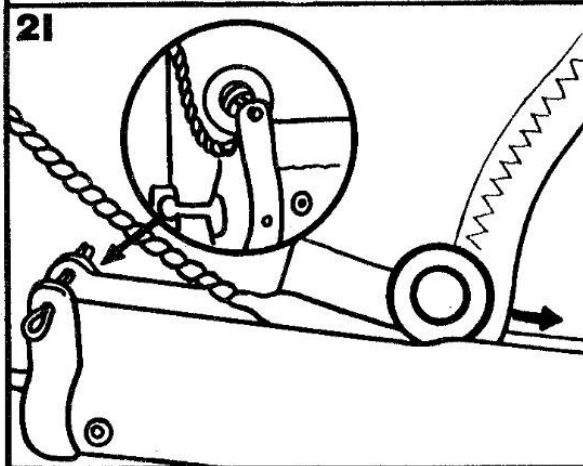
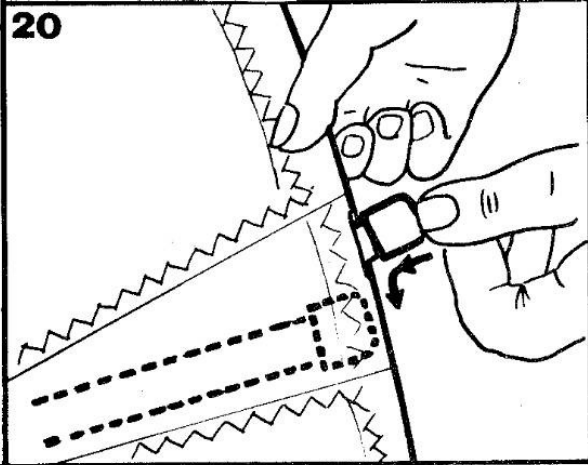
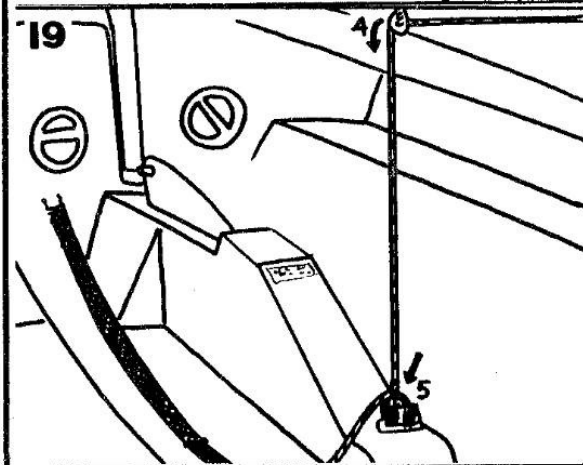
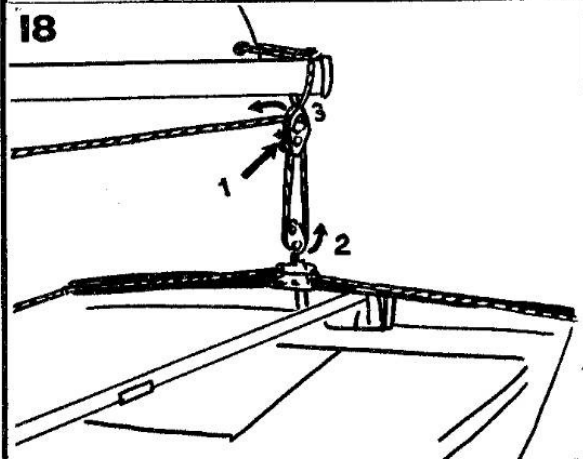
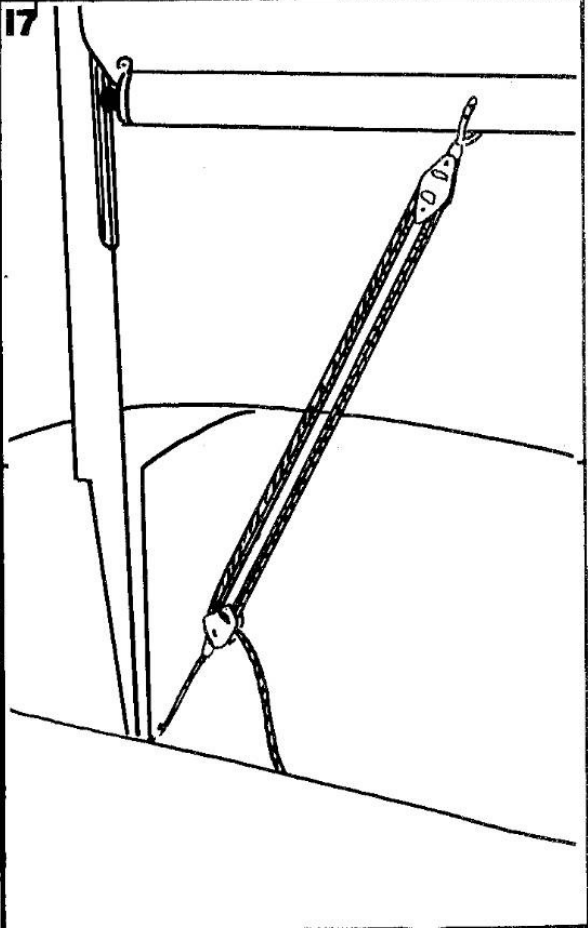
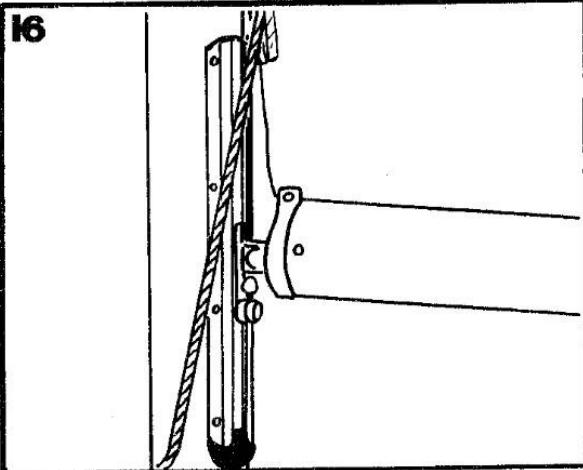

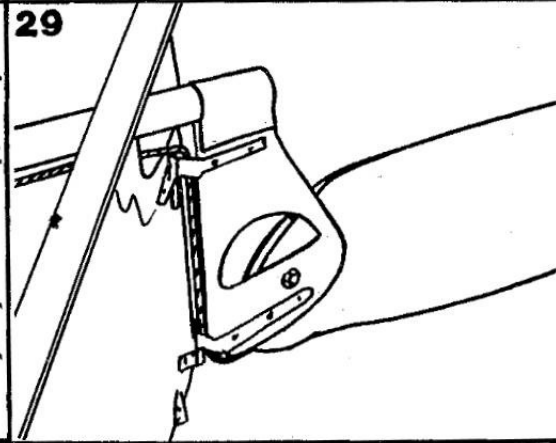
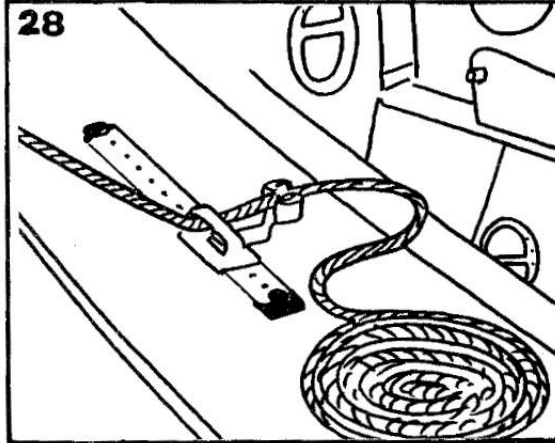
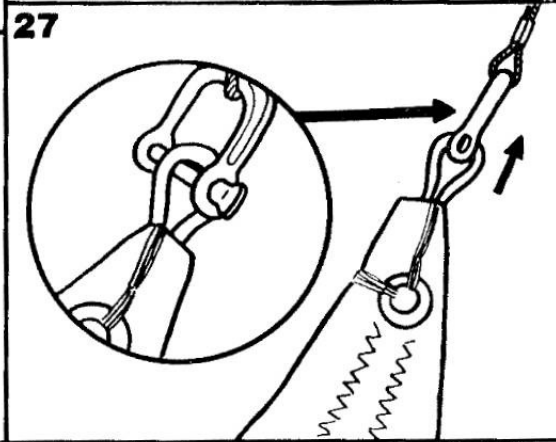
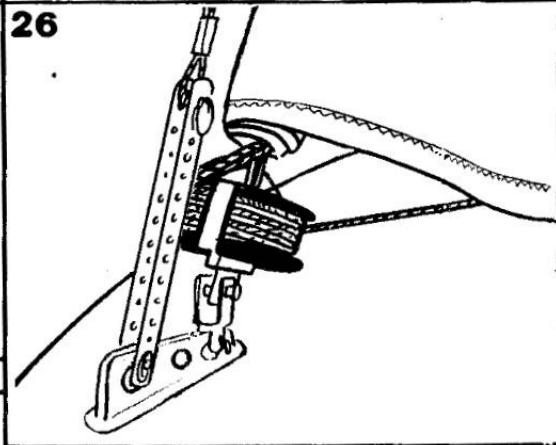
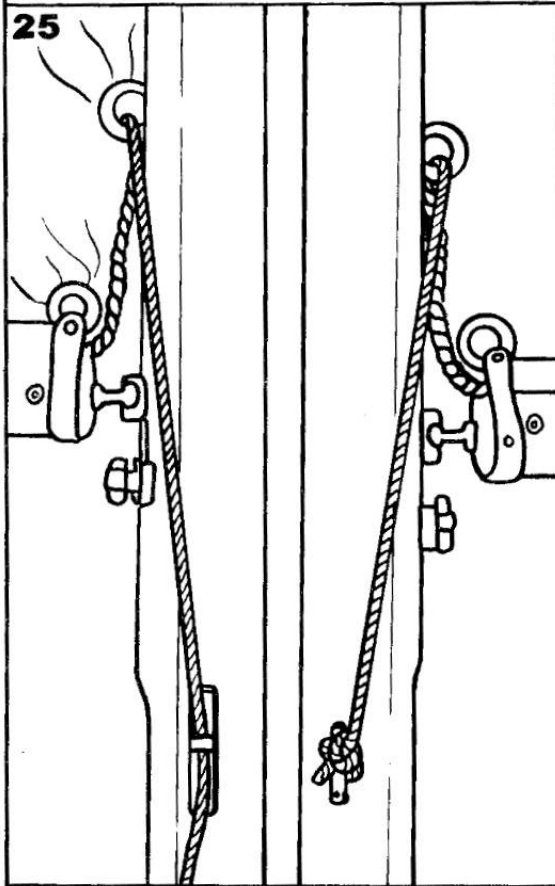
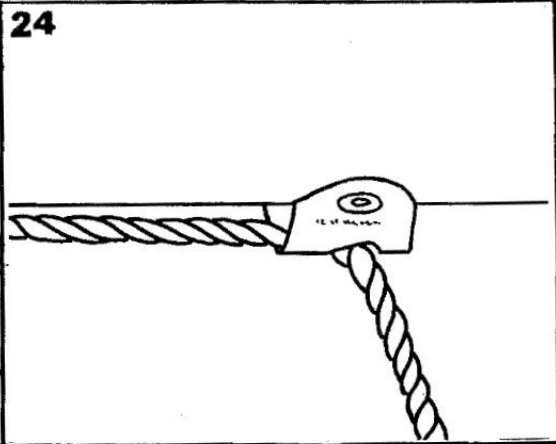
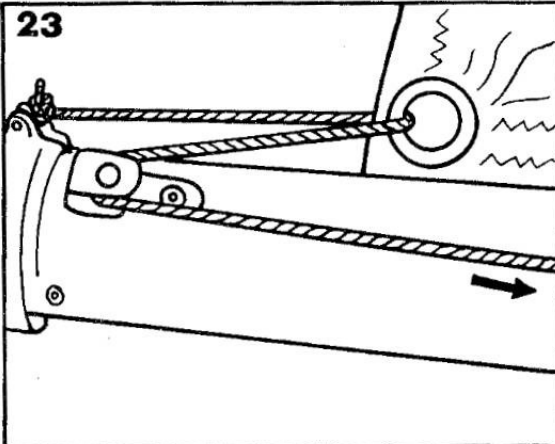



PINAKEP

